

DATA SHEET

VADS 1500+

SCREW VACUUM PUMPS

contact-free and oil-free compression, air-cooled and direct drive with VARIAIR frequency inverter and VARIAIR Controller+

MAKE IT BECKER.

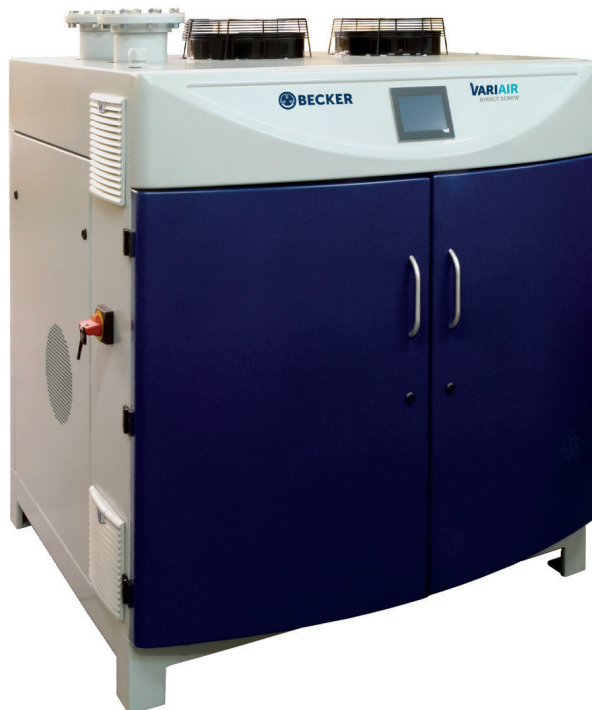

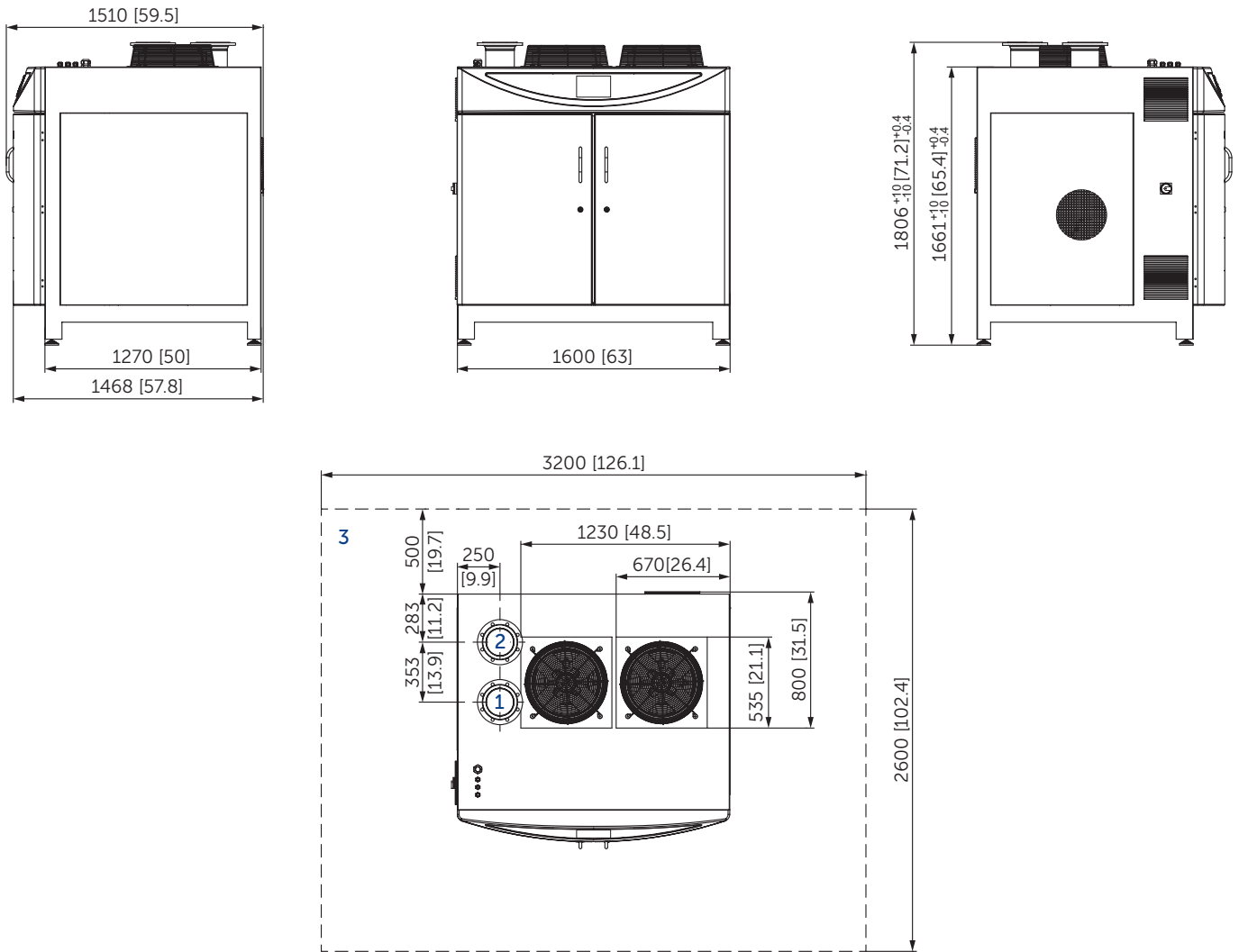

VARIAIR
DIRECT SCREW

 **BECKER**



- 1 Vacuum connection (DIN 2565 - G6)
- 2 Pressure connection (DIN 2565 - G6)
- 3 Installation surface
- Dimensions in mm [inch]

Suction air rate	Vacuum absolute	Drive speed	Emission sound pressure level ¹⁾		Weight	 U-V-W 3~ L1-L2-L3	
m ³ /h max.	mbar	rpm max.	110 Hz	200 Hz	kg	Frequency inverter VAU30/VADS1500+	A max.
1380	200	12000 (110–200 Hz)	75	80	1200	30 kW • 380–480 V • 50/60 Hz	100

¹⁾ According to DIN EN ISO 11203, accuracy class of measurement: class 2, extended measurement uncertainty: 3 dB
1 m [39.4 inch] distance, at medium load, both connection sides piped

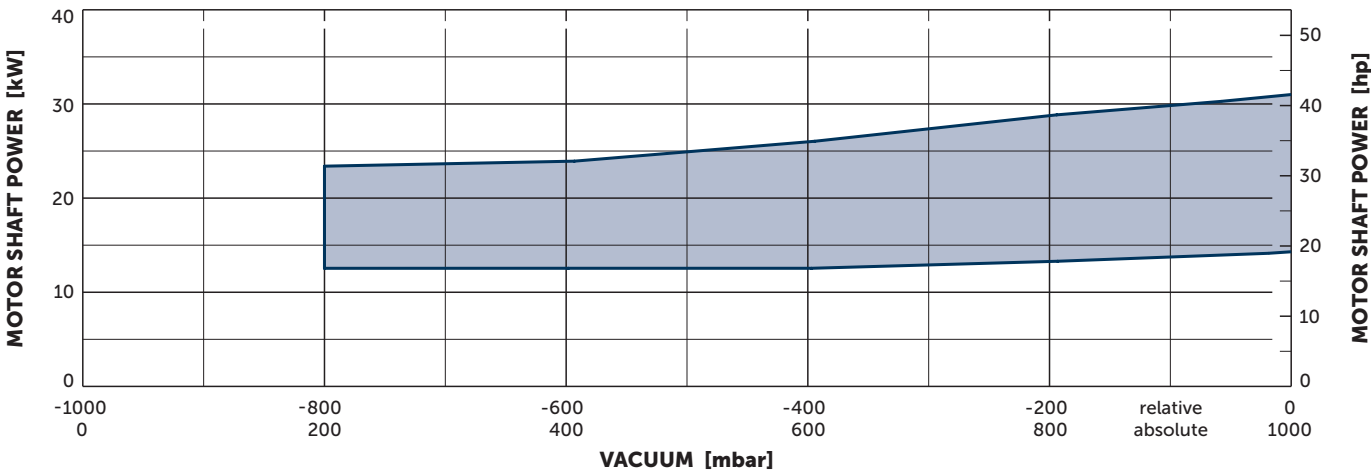
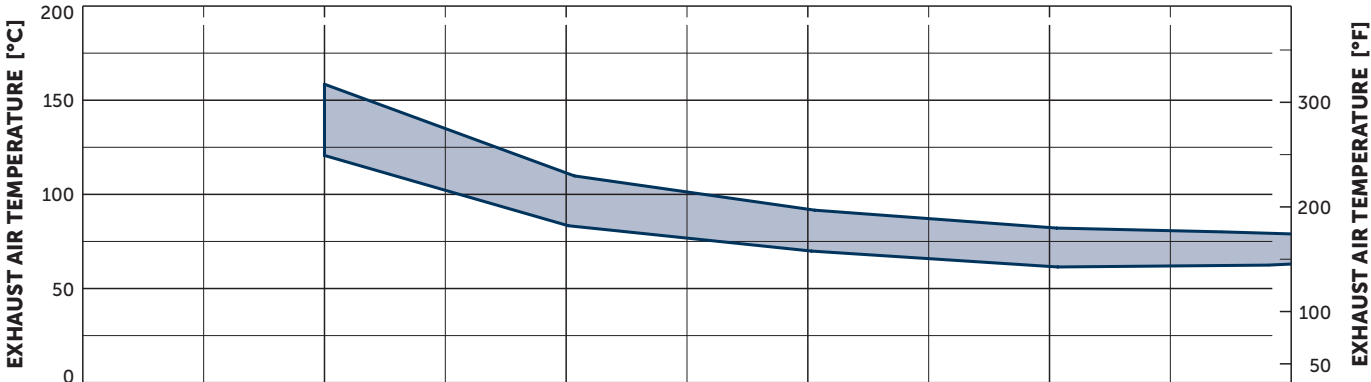
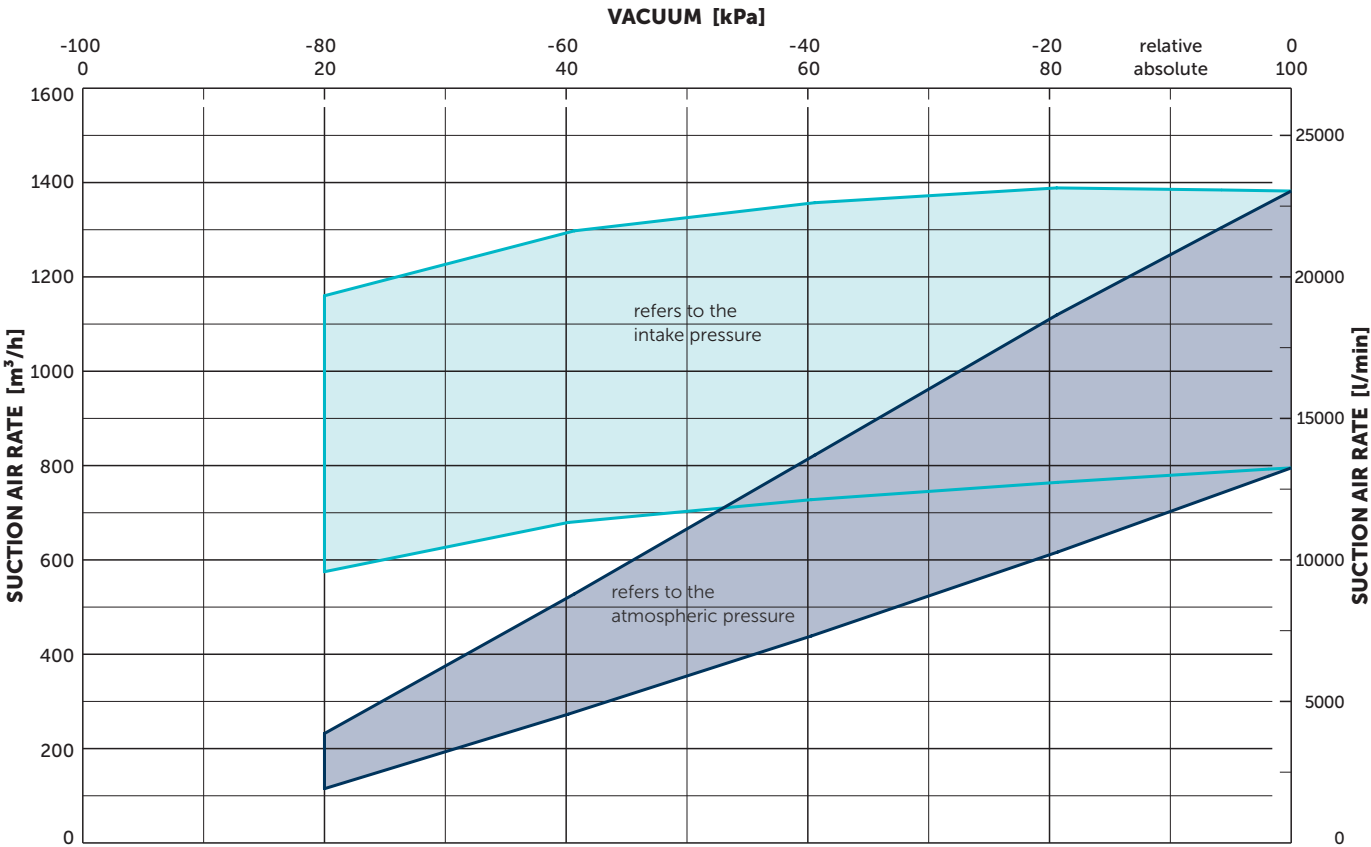

Reference data (atmosphere): 1000 mbar (100 kPa), 20°C (68°F)
Tolerance: ±5%



MAKE IT BECKER.